

HPS4050x055 5V 55A 1/2 Brick Converter

Half-Brick



Features

- High efficiency, 91.5% (5.0V/55A)
- Excellent thermal performance
- Industry standard footprint and pin out
- Low profile, 0.37" (9.4mm)
- Robust stability
- Monotonic start-up
- No minimum load required
- Fixed frequency operation
- Basic insulation, 1500V
- Designed to meet UL[†]60950

Applications

- Wireless Networks
- Telecom / Datacom
- Electronic Data Processing / Servers
- Distributed Power Architectures

Options

- Baseplate (for standard heatsink)
- Double output pin for output current >60A
- Primary side active current sharing
- Auto-restart after fault shutdown
- Negative/Positive enable logic
- Case pin
- Various lead lengths

NetPower Technologies' HPS Series of high current, low profile, half-brick DC/DC converters deliver high current with high efficiencies and excellent thermal performance in a single board, open frame patented design. The HPS Series is designed to operate without a baseplate and/or heatsink due to the low power dissipation and superior thermal management properties. For applications in extreme thermal environments, however, a baseplate option is provided. The HPS converters are offered with an optional active current sharing feature that will current share within 10% between each converter. This feature can be used to increase output power, or redundancy for customer's requirement. An optional feature of dual output pins ("Double-P") is also available to provide more contact surface area for customers at the higher output current levels.

The HPS Series of converters also features a monotonic start-up from both the input voltage and the ON/OFF control under all load conditions (including pre-biased output). The HPS converters have a fast dynamic response and are stable over the full range of input voltage, load current, load capacitance, capacitor ESR, and temperature. The converters feature tight line and load regulations, and fully protected from abnormal conditions of input/output voltages, output current and operating temperature.

[†] UL is a registered trademark of Underwriters Laboratory Inc.

Absolute Maximum Ratings

Excessive stresses over these absolute maximum ratings can cause permanent damage to the converter. Also, exposure to absolute maximum ratings for extended periods of time can adversely affect the reliability of the converter. Operation should be limited to the conditions outlined under the Electrical Specification Section.

Parameter	Symbol	Min	Max	Unit
Input Voltage (continuous)	V_i	-0.5	80	Vdc
Input Voltage (continuous, > 100ms, non-operating)	V_i	-	100	Vdc
Transient Input Voltage (<100ms continuous operating)	$V_{i,trans}$	-	100	Vdc
I/O Isolation Voltage (for 1 minute)		1500	-	Vdc
Operating Ambient Temperature (See Thermal Consideration section)	T_o	-40	85*	°C
Storage Temperature	T_{stg}	-55	125	°C

* For operation above 85°C ambient temperature, please consult NetPower for derating guidance.

Electrical Specifications

These specifications are valid over the converter's full range of input voltage, resistive load, and temperature unless noted otherwise.

Input Specifications

Parameter	Symbol	Min	Typ	Max	Unit
Input Voltage	V_i	36	48	75	Vdc
Input Current	$I_{i,max}$	-	-	10	A
Quiescent Input Current ($V_{in} = 48V$)	$I_{i,Qsnt}$	-	160	200	mA
Standby Input Current	$I_{i,stdby}$	-	4	6	mA
Inrush Transient	I^2t	-	-	1.0	A ² s
Input Reflected-ripple Current, Peak-to-peak (5 Hz to 20 MHz, 12 μ H source impedance)	-	-	20	-	mA
Input Ripple Rejection (120 Hz)	-	-	60	-	dB
Input Turn-on Voltage Threshold	-	34	35	36	V
Input Turn-off Voltage Threshold	-	29	32	33	V
Input Voltage ON/OFF Hysteresis	-	1	3	4	V

Output Specifications

Parameter	Symbol	Min	Typ	Max	Unit
Output Voltage Set Point ($V_i = 48V$; $I_o = I_{o,max}$; $T_a = 25^\circ C$)	-	4.92	5.00	5.08	Vdc
Output Voltage Set Point (over all conditions)	-	4.85	-	5.15	Vdc
Output Regulation:					
Line Regulation ($V_i = 36V$ to $75V$, $I_o = 1/2$ of load)	-	-	0.05	0.2	% V_o
Load Regulation ($I_o = I_{o,min}$ to $I_{o,max}$, $V_i = 48V$)	-	-	0.05	0.2	% V_o
Temperature ($T_a = -40^\circ C$ to $85^\circ C$)	-	-	15	50	mV
Output Ripple and Noise Voltage RMS	-	-	-	30	mVrms
Peak-to-peak (5 Hz to 20 MHz bandwidth, $V_{in} = 48V$)	-	-	-	100	mVp-p
External Load Capacitance	-	-	-	60,000	μ F
Output Current	I_o	0	-	55	A
Output Power	P_o	0	-	275	W



Output Specifications (continued)

Parameter	Symbol	Min	Typ	Max	Unit
Output Current-limit Trip Point (Vo = 90% of Vo,nom)	Io,cli	56.7	63.3	71.5	A
Output Short-circuit Current			0		A
Efficiency (Vi = 48V; Io = 65A, TA = 25°C)	η	-	91.5	-	%
Output Over Voltage trip point		5.62	6.25	6.88	V
Switching frequency	-	280	300	320	kHz
Dynamic Response (Vi = 48V; Ta = 25°C; Load transient 0.1A/ μ s) Load step from 50% to 75% of full load: Peak deviation Settling time (to 10% band of Vo) Load step from 50% to 25% of full load: Peak deviation Settling time (to 10% band of Vo)			6 250 6 250		%Vo μ s %Vo μ s

General Specifications

Parameter	Symbol	Min	Typ	Max	Unit
Remote Enable Negative Logic: Logic Low – Module On Logic High – Module Off Positive Logic: Logic High – Module On Logic Low – Module Off Logic Low: ION/OFF = 1.0mA VON/OFF = 0.0V Logic High: ION/OFF = 0.0 μ A Leakage Current Turn-on Time (Io = full load, Vo within 1% of setpoint)	- - - - VON/OFF ION/OFF VON/OFF ION/OFF	- - - - 0 - - -	- - - - - - - 4	- - - - 1.2 1.0 15 50 8	- - - - V mA V μ A ms
Output Voltage Trim Range	-	80	-	110	%Vo
Output Voltage Remote-sense Range	-	-	-	0.5	V
Output Current Sharing Accuracy (at rated load)	-	-	-	10	%
Over-temperature Protection	To	-	120	-	°C
Isolation Capacitance	-	-	4700	-	pF
Isolation Resistance	-	10	-	-	M Ω
Calculated MTBF (Bellcore TR-332)			2.4		10 ⁶ -hour

Characteristic Curves

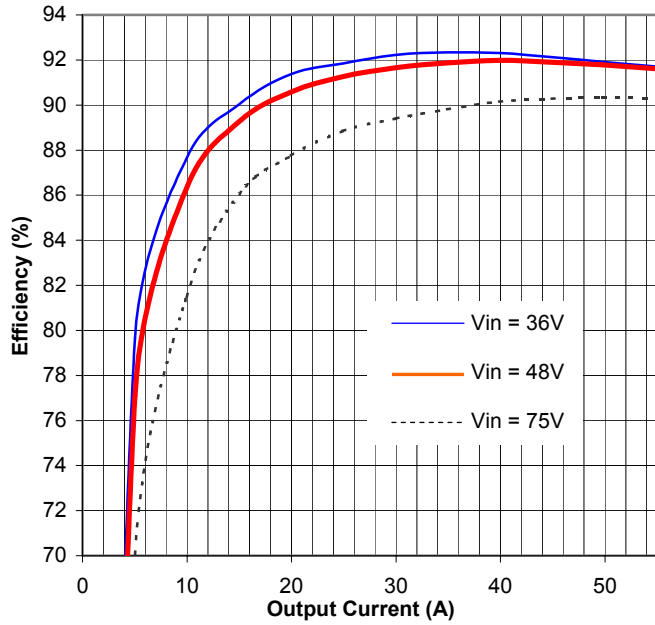

Figure 1. Efficiency vs. Load Current (25°C)

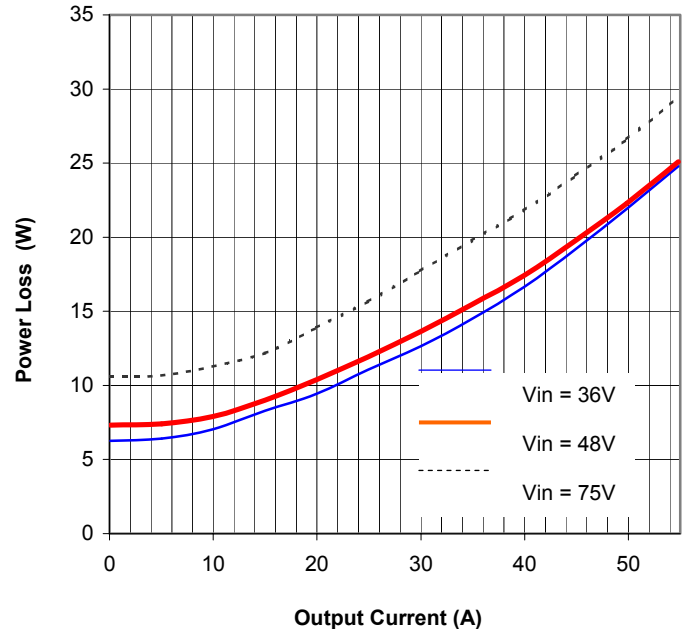

Figure 2. Power Loss vs. Load Current (25°C)

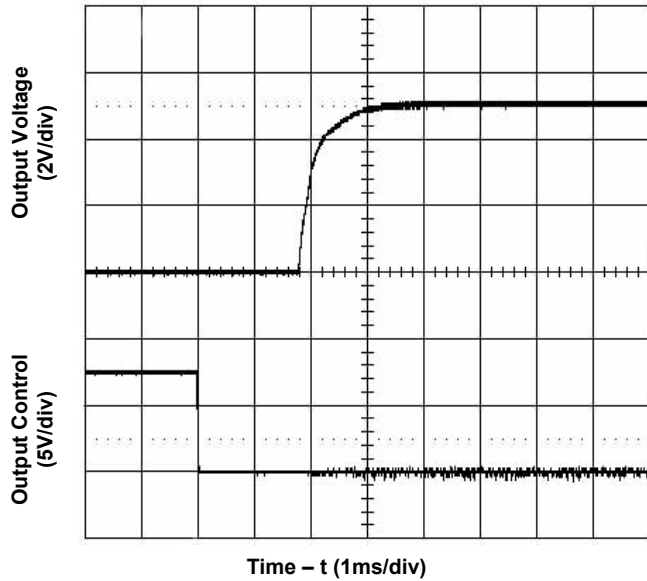

Figure 3. Start-Up from Enable Control

Input voltage 48V, Output current 55A

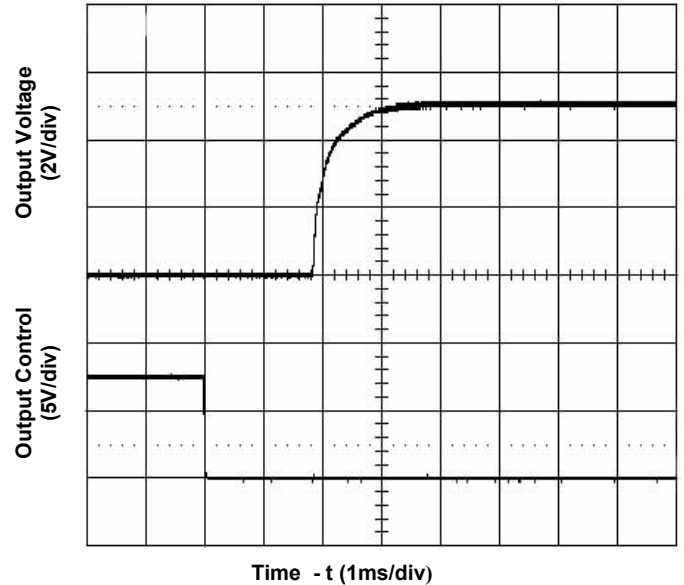
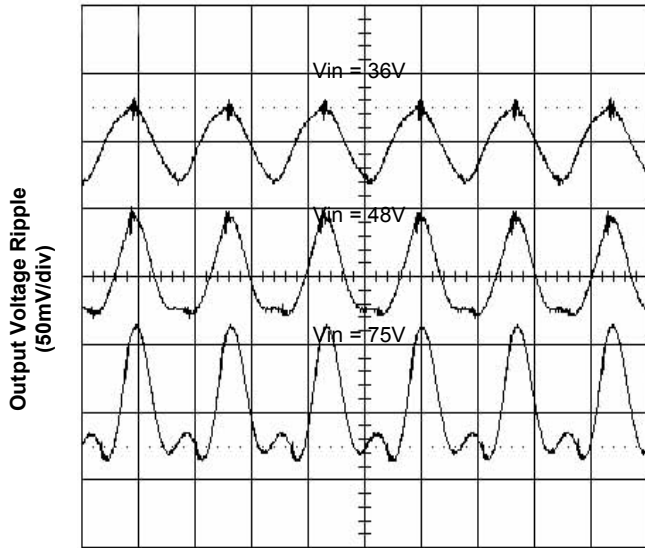
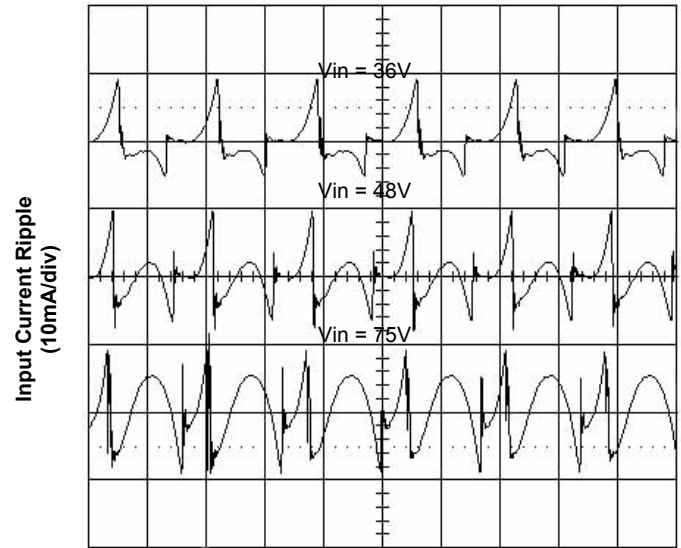

Figure 4. Start-Up from Enable Control

Input voltage 48V, Output current 0A



Time - t (2µs/div)
Figure 5. Output Ripple Voltage at 55A Load



Time - t (2µs/div)
Figure 6. Input Reflected Ripple Current at 55A Load

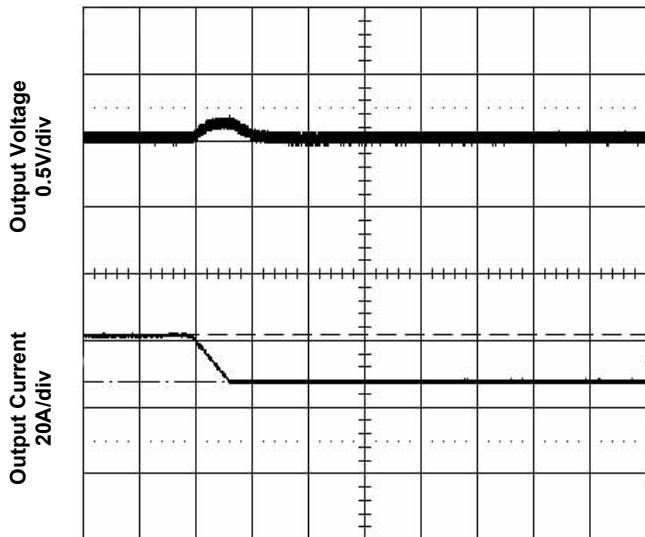

Time - t (200µs/div)
Figure 7. Transient Load Response

Top: Output voltage deviation
Bottom: Load current step (-25% full load)
Test Cond.: Output current 27.5A (50% full load), Input voltage 48V, Slew rate 0.1A/µs

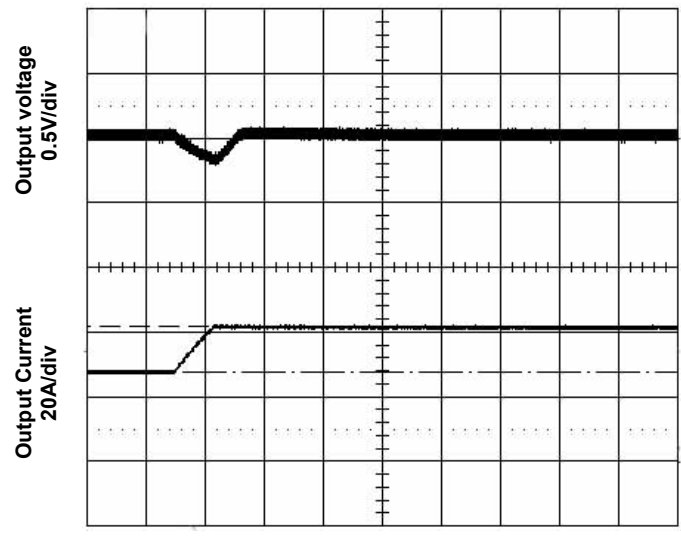

Time - t (200µs/div)
Figure 8. Transient Load Response

Top: Output voltage deviation
Bottom: Load current step (+25% full load)
Test Cond.: Output current 27.5A (50% full load), Input voltage 48V, Slew rate 0.1A/µs

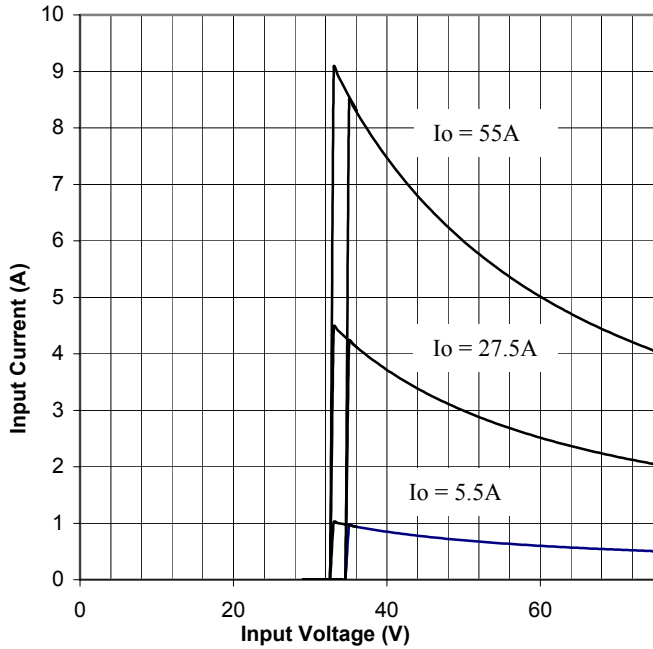

Figure 9. Input Characteristics

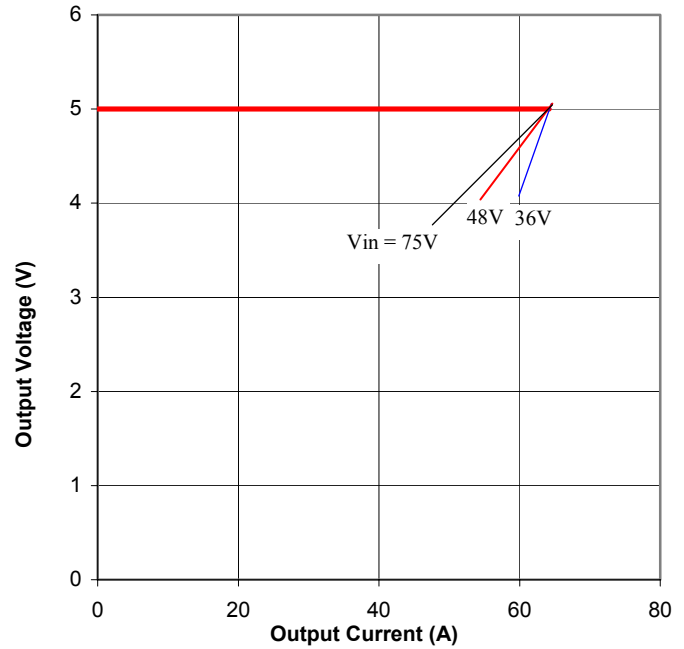

Figure 10. Output Characteristics

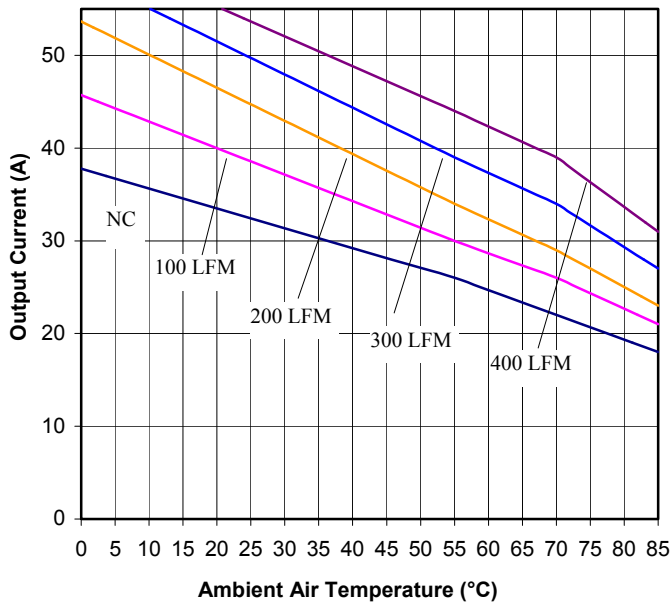

Figure 11. Current Derating Curve for Airflow Direction 3
(Ref. Fig. 12 for Airflow Direction; $V_{in} = 48V$
open frame unit using socket interface)

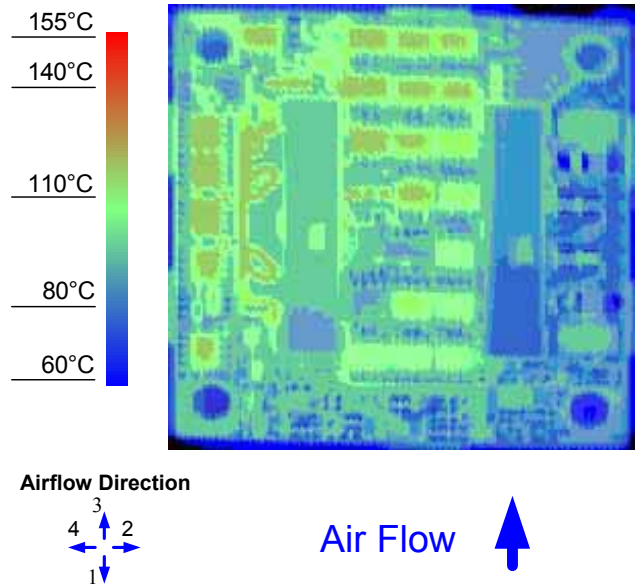

Figure 12. Thermal Image for Airflow Direction 3
(34A output, 55°C ambient, 200 LFM, $V_{in} = 48V$
open frame unit using socket interface)

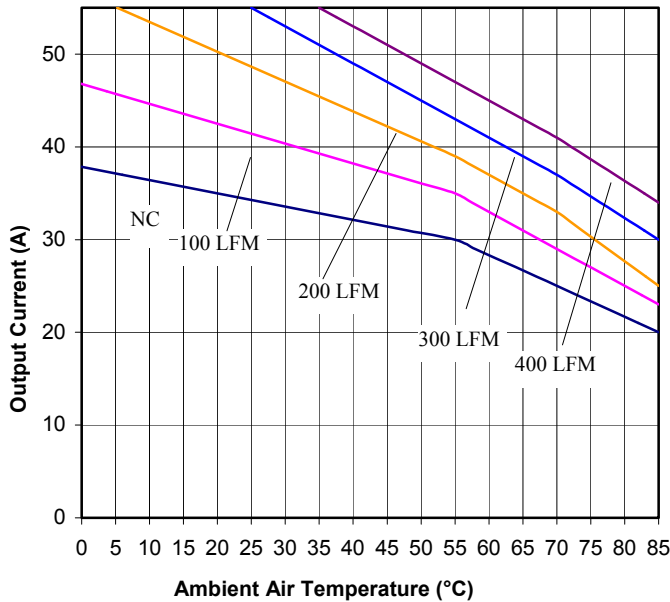

Figure 13. Current Derating Curve for Airflow Direction 2
(Ref. Fig.14 for Airflow Direction; Vin = 48V
open frame unit using socket interface)

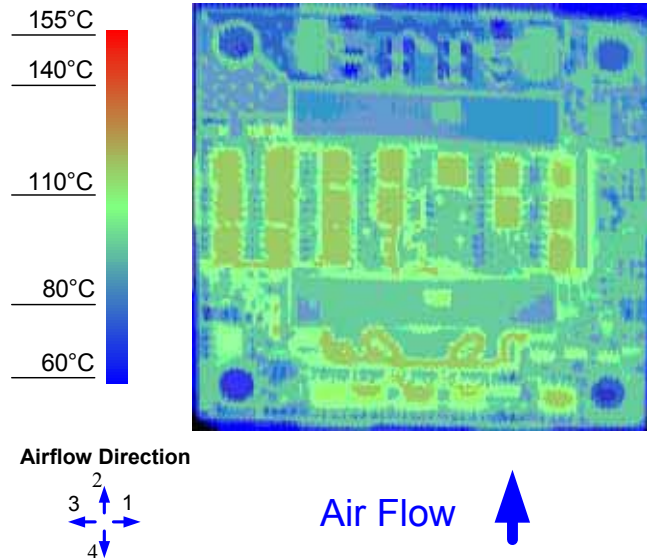

Figure 14. Thermal Image for Airflow Direction 4
(39A output, 55°C ambient, 200 LFM, Vin = 48V
open frame unit using socket interface)

Feature Descriptions

Remote ON/OFF

The converter can be turned on and off by changing the voltage between the ON/OFF pin and Vin(-). The HPS Series of converters is available with factory selectable positive logic and negative enabling logic.

For the negative control logic, the converter is ON when the ON/OFF pin is at a logic low level and OFF when the ON/OFF pin is at a logic high level. For the positive control logic, the converter is ON when the ON/OFF pin voltage is at a logic high level and OFF when the ON/OFF pin voltage is at a logic low level.

With the internal pull-up circuitry, a simple external switch between the ON/OFF pin and Vin(-) can control the converter. A few example circuits for controlling the ON/OFF pin are shown in Fig. 15, 16 and 17.

The logic low level is from 0V to 1.2V and the

maximum switch current during logic low is 1mA. The external switch must be capable of maintaining a logic-low level while sinking up to this current. The maximum voltage at the ON/OFF pin generated by the converter internal circuitry is less than 15V. The maximum allowable leakage current is 50µA.

Remote SENSE

The remote SENSE pins are used to sense the voltage at the load point to accurately regulate the load voltage and eliminate the impact of the voltage drop in the power distribution path.

SENSE(+) and SENSE(-) pins should be connected to the point where regulation is desired. The voltage difference between the SENSE pins and the output pins must not exceed 0.5V:

$$[V_{out(+)} - V_{out(-)}] - [SENSE(+) - SENSE(-)] < 0.5V$$

When remote sense is not used, the SENSE pins should be connected to their corresponding output terminals (positive and negative). If the SENSE pins are left floating, the converter will deliver an output



voltage slightly higher than its specified typical output voltage. Since the OVP (output over-voltage protection) circuit senses the voltage across the output pins (Pin 5 and Pin 9), the total voltage rise should not exceed the minimum OVP setpoint given in the Specifications table.

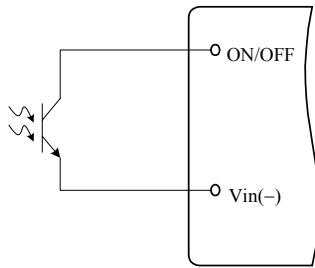

Fig. 15 Opto Coupler Enable Circuit

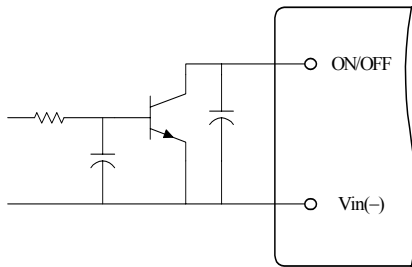

Fig. 16 Open Collector Enable Circuit

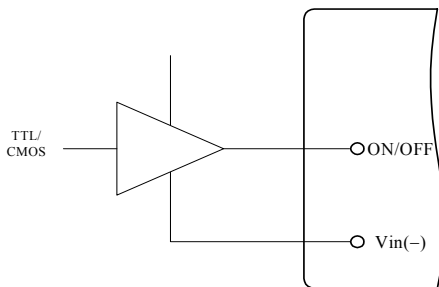

Fig. 17 Direct Logic Drive

Output Voltage Adjustment (Trim)

The trim pin allows the user to adjust the output voltage set point. To increase the output voltage, an external resistor is connected between the TRIM pin and SENSE(+). To decrease the output voltage, an external resistor is connected between the TRIM pin and SENSE(-). The output voltage trim range is 80% to 110% of its specified nominal output voltage. The circuit configuration for trim down operation is shown in Fig. 20.

To decrease the output voltage, the value of the external resistor should be

$$R_{down} = \left(\frac{100}{\Delta} - 2 \right) (k\Omega)$$

Where

$$\Delta = \left(\frac{|V_{nom} - V_{adj}|}{V_{nom}} \right) \times 100$$

and

V_{nom} = Nominal Voltage

V_{adj} = Adjusted Voltage

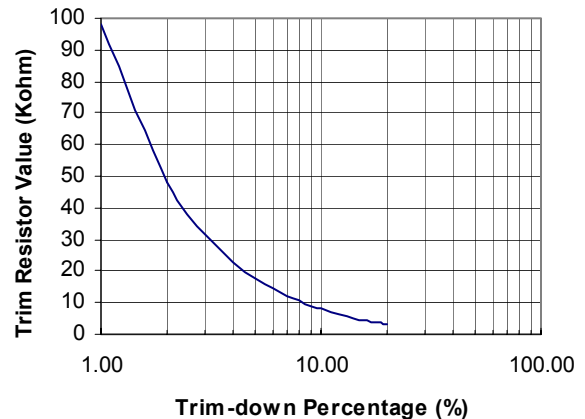

Fig. 18 Trim-Down Resistor Selection

The circuit configuration for trim up operation is shown in Fig. 21.

To increase the output voltage, the value of the resistor should be

$$R_{up} = \left(\frac{V_o(100 + \Delta)}{1.225 \cdot \Delta} - \frac{(100 + 2 \cdot \Delta)}{\Delta} \right) (k\Omega)$$

Where

V_o = Nominal Output Voltage

As the output voltage at the converter output terminals are higher than the specified nominal level when using the trim up and/or remote sense functions, it is important not to exceed the maximum power rating of the converter as given in the Specifications table.

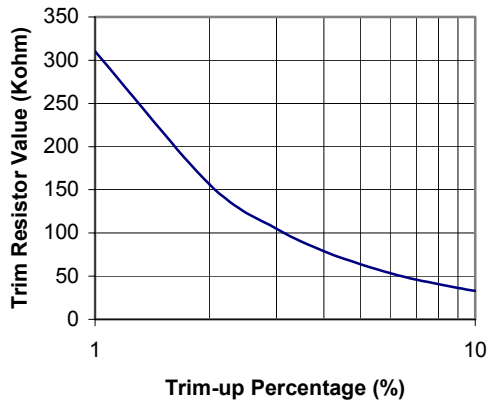

Fig. 19 Trim-Up Resistor Selection

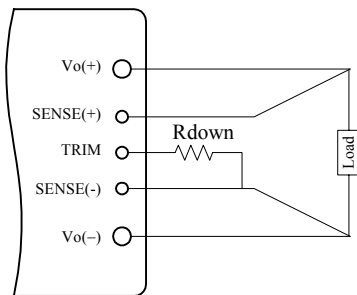

Fig. 20 Circuit to Decrease Output Voltage

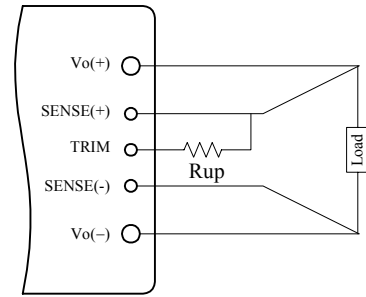

Fig. 21 Circuit to Increase Output Voltage

Active Current Sharing (Paralleling)

The active current sharing feature allows multiple converters to share load current within 10% of the rated current. For the parallel operation of multiple converters, Pin 2 on each converter should be connected together. It is suggested to have a ground plane on the application board for $V_{in}(-)$ to reduce the ground noise impact on the current share accuracy. The loop formed by the trace connecting the parallel pins and the ground trace should be minimized to avoid noise coupling into the current sharing circuitry. A typical current sharing/paralleling scheme for the HRS Series of converters is shown in Fig. 22.

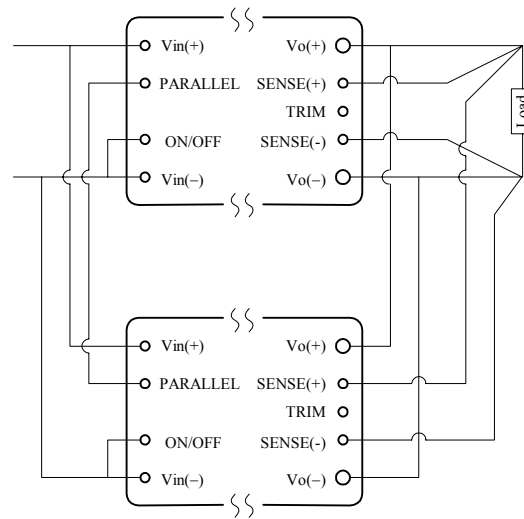

Fig. 22 Circuit Configuration for Active Current Sharing (Paralleling)

Input Under-Voltage Lockout

This feature prevents the converter from turning on until the input voltage reaches 35V typical, and shuts down the converter if the input voltage falls below 32V typical. The 3V hysteresis prevents oscillations.

Input Over-Voltage Protection

This feature turns off the converter when the input voltage exceeds 78V typical if exceed 100ms. The converter will automatically resume operation when the input voltage falls below 77V. The converter can continue the operation during a 100V surge for 100ms.

Output Over-Current Protection

As a standard feature, the converter will latch off when the load current exceeds the current limit. The converter can be restarted by toggling the ON/OFF switch or recycling the input voltage. With the auto-restart option, the converter will operate in a hiccup mode (repeatedly try to restart) until the over-current condition is cleared.

Output Over-Voltage Protection

If the voltage across the output pins exceeds the output voltage protection threshold as given in the Specifications table, the converter will shut down to protect the converter and the load.

As a standard feature, the converter will shut down and latch off when this fault occurs. The converter can be restarted by toggling the ON/OFF switch or recycling the input voltage. With the auto-restart option, the converter will operate in a hiccup mode until the over-voltage cause is cleared.

Thermal Shutdown

As a standard feature, the converter will shut down and latch off if an over-temperature condition is detected. The converter has a temperature sensor located at a carefully selected position in the converter circuit board, which represents the thermal condition of key components of the converter.

The thermal shutdown circuit is designed to turn the converter off when the temperature at the sensor reaches 120°C. The module can be restarted by toggling the ON/OFF switch or recycling the input voltage. With the auto-restart option, the converter will resume operation after the converter cools down.

Design Considerations

Input Source Impedance

As with any DC/DC converter, the stability of the HRS converters may be compromised if the source impedance is too high or inductive. It's desirable to keep the input source ac-impedance as low as possible. Although the converters are designed to be stable without an additional input capacitor for typical source impedance, it is recommended to use at least a 33 - 100 μ F low ESR electrolytic capacitor at the input of the converter to reduce the potential impact of the source impedance. This electrolytic capacitor should have sufficient RMS current rating over the operating temperature range.

Safety Considerations

The HPS Series of converters are designed in accordance with EN 60950 Safety of Information Technology Equipment Including Electrical Equipment. The converters are designed to meet 1500V Basic Insulation requirements in UL 60950, Safety of Information Technology Equipment and applicable Canadian Safety Requirement, and ULc 60950. Flammability ratings of the PWB and plastic components in the converter meet 94V-0.

For the converter to meet basic insulation requirements when a baseplate or heatsink option is selected, the case pin must be left floating or connected to a primary or secondary circuit through a capacitor with the appropriate voltage rating. If no baseplate or heatsink is used, the case pin can be connected directly to any primary circuit.

To protect the converter and the system, an input line fuse is highly recommended on the un-grounded input end.

A maximum rating of 20A normal-blow fuse should be connected at the un-grounded input lead of each HPS

converter.

Thermal Considerations

The HRS Series of converters can operate in various thermal environments. Due to the high efficiency and optimal heat distribution, these converters exhibit excellent thermal performance. Most heat generating components are mounted on the topside of the module, so the heat can be easily removed by conduction, convection and radiation. Proper cooling can be verified by monitoring the temperature of key components. Figure 23 shows a recommended temperature monitoring point. The temperature at this location should not continuously exceed 120 °C.

The maximum allowable output power of any power converter is usually determined by the electrical design and the maximum operating temperature of its components. The HRS Series of converters has been tested comprehensively under various conditions to generate the derating curves with the consideration for long term reliability.

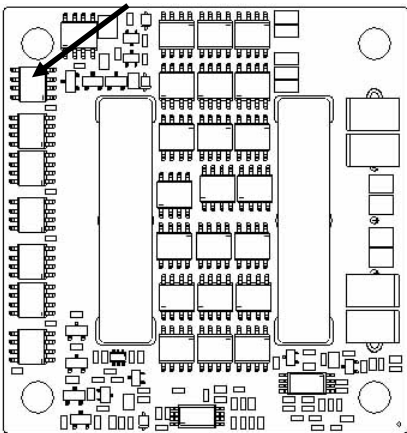

Figure 23. Temperature Monitoring Location

The thermal derating curves are highly influenced by the test conditions. One of the variables is the interface method between the converter and the test fixture board. There is no standard method in the industry for the derating tests. Some suppliers use sockets to plug in the converter, while others solder the converter into the fixture board. It should be noted that these two methods produce different results for a given converter. When the converter is soldered into the fixture board, the thermal

performance of the converter is usually improved compared to using sockets due to the reduction of the contact loss and the thermal impedance from the pin to the fixture board. Other factors affecting the results include the board spacing, construction (especially copper weight, holes and openings) of the fixture board and the spacing board, temperature measurement method and the ambient temperature measurement point. NetPower's thermal derating curves are obtained using socket interface on a PWB fixture board and socket interface on a PWB spacing board with no opening, a board-to-board spacing of 1", and thermal couplers to monitor all temperatures. For thermal considerations specific to your application environment, please contact NetPower's technical support team for further advice.

Heat Transfer Without a Baseplate and/or Heatsink

As with other single-board DC/DC converter designs, convection heat transfer is the primary cooling means for converters without a baseplate. Therefore, airflow speed should be checked carefully for the intended operating environment. Increasing the airflow over the converter enhances the heat transfer via convection.

Figure 11 and 13 shows the current derating curves under nominal input voltage. To maintain long-term reliability, it is advised to operate the module within these curves. Note that the natural convection condition was measured at 0.05 m/s to 0.15 m/s 10ft./min. to 30 ft./min.

Heat Transfer With a Baseplate and/or Integrated Heatsink

The HPS Series of converters has the options of using a baseplate, and integrated heatsink for enhanced thermal performance.

The maximum height of the converter with the baseplate option is 0.50". The use of an additional heatsink or cold-plate can further improve the thermal performance of the converter. With the baseplate option, a standard quarter-brick heatsink can be attached to the converter using M3 screws.

An integrated-heatsink option that combines the baseplate and heatsink into one assembly is also



offered for the HPS Series of converters. The maximum converter height with this option is not greater than 0.75", but the converter thermally outperforms the baseplate version with a 0.50" heatsink attached.

An optional case pin is available for the baseplate and integrated heatsink options.

EMC Considerations

The HPS Series of converters meet EN55022 class B and FCC part 15J requirements with an external filter. The EMC performance of the converter is related to the layout and filtering design of the customer board. As with other switching-mode power supplies, careful layout and adequate filtering around the module are important to confine noise generated by the switching in the converter and to optimize system EMC performance.

For assistance with designing for EMC compliance, please contact NetPower's technical support team at support@netpowercorp.com.



Mechanical Information

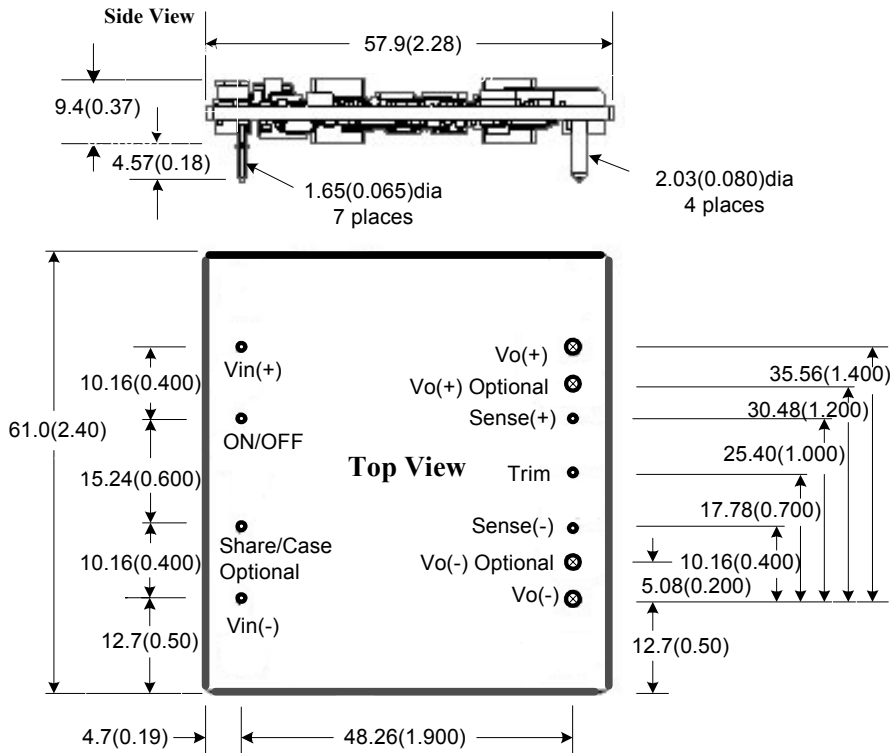

Figure 24. Open Frame Converter

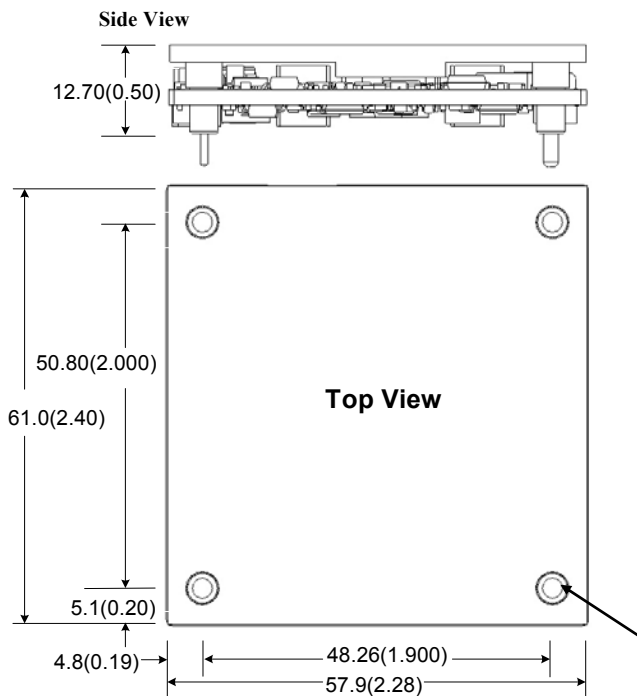

Figure 25. Converter with Optional Baseplate

Notes:

- 1) All dimensions in mm (inches)
Tolerances: .x ± .5 (.xx ± 0.02)
.xx ± .25 (.xxx ± 0.010)
- 2) Input and control pins are 1.02mm (0.040") dia. with 1.68mm (0.066") dia. standoff shoulders.
- 3) Output pins are 2.03 mm (0.080") dia.
- 4) All pins are coated with 90%/10% solder, Gold, or Matte Tin over Nickel underplating
- 5) Height: 9.4mm (0.37 in.) +/-0.635mm
- 6) Weight: 61 g
- 7) Workmanship: Meet or exceeds IPC-A-610 Class II
- 8) Torque applied on M3 screw should not exceed 6in-lb. (0.7 Nm)
- 9) Baseplate flatness tolerance is 0.10mm (0.004") TIR for surface
- 10) Optional parallel pin can also be the optional "case" pin. but both options cannot be ordered on the same products at the same time.

M3x0.5 Threaded Insert
4 Places
See Notes 8 and 9



Part Numbering System

Series Name	Input Voltage	Output Voltage	ON/OFF Logic	Output Current	Pin Feature	Electrical Options	Mechanical Options	
HPS	4	050	N	055	N	2	1	
							Lea-free, RoHS Compliant	Leaded (RoHS-5 Compliant)
HPS	4- 36-75V 2- 18-36V	Unit: 0.1V 120-12.0V	P- positive N- negative	Unit: A 025-25A	K - 0.110" N - 0.145" R - 0.180" L: 0.110", Double-Pin O: 0.145" Double-Pin T: 0.180" Double-Pin S: SMT	0- no option 1- Current sharing 2- auto-restart 3- current sharing and auto-restart	5- no option 6- baseplate 8- case pin with baseplate;	0- no option 1- baseplate 3- case pin with baseplate;

Note: Dual output pins are available only on models with output current higher than 50A.

Part Numbering Example: **HRS4050N055N21**

Denotes a half brick module with 48 Vin single output (i.e., 36-75V), 5.0Vout, negative remote control logic, 55Aout, 0.145" pin length, auto-restart feature, and a baseplate.

For more information, please contact:

 **NetPower** Technologies, Inc.
Toll Free: 866-NETPOWER (638-7693)
Local Phone: 972-560-0500
Fax: 972-560-0210
E-mail: sales@netpowercorp.com
1680 Prospect Drive, Suite 200, Richardson, TX 75081

Warranty

NetPower offers a two (2) year limited warranty. Complete warranty information is listed on our web site or is available upon request. Information furnished by NetPower is believed to be accurate and reliable. However, no responsibility is assumed by NetPower for its use, nor for any infringements of patents or other rights of third parties which may result from its use. No license is granted by implication or otherwise under any patent or patent rights of NetPower.